



---

Hygiene  
Accessibility  
Design

---

## **Solutions Escalier** Stair Solutions

**Gerflor**<sup>®</sup>

# L'offre la plus complète du marché

The most complete solution on the market

## Solutions escaliers

Solutions for stairs



### Tarastep Pro

La solution tout en 1 qui combine **hygiène et accessibilité**

The all in 1 solution which combines hygiene and accessibility

- ✓ **Accessibilité** / Access for all
- ✓ **Coordonnabilité palier** / Matching with landing
- ✓ **Hygiène** / Hygienic
- ✓ **Facilité pose** / Easy installation



### Nez de marche

Stair nosing

Le profilé idéal pour l'**accessibilité** et le **choix infini** du décor pour le sol

The ideal profile for accessibility and unlimited design possibilities

- ✓ **Accessibilité** / Access for all
- ✓ **Coordonnabilité palier** / Matching with landing
- ✓ **Hygiène** / Hygienic
- ✓ **Facilité pose** / Easy installation



### Profilé design

Design profile

Le profilé parfait pour l'**esthétisme** avec la gamme **LVT**

The perfect profile that compliments our LVT ranges

- ✓ **Accessibilité** / Access for all
- ✓ **Coordonnabilité** / Matching with floor
- ✓ **Hygiène** / Hygienic
- ✓ **Facilité pose** / Easy installation



## Solutions Accessibilité

Access for all solutions



### Eveil de la vigilance

Warning

Ce dispositif attire l'attention des personnes à l'approche d'un danger.

This device will raise people's attention in front of a danger.

- ✓ **Alertile**
- ✓ **Easyplot**



### Guidage

Guiding

Ces produits permettent de guider les personnes avec une déficience visuelle dans les espaces

These products will guide people with visual disabilities

- ✓ **Main courante** / Handrail **Spm**
- ✓ **Easyguide**



### Repérage

Tracking

L'incrustation de pictogrammes aide le repérage des espaces dans le bâtiment

The embedded pictograms will help people find the right way

- ✓ **Technologie découpe jet d'eau** / Waterjet cutting technology

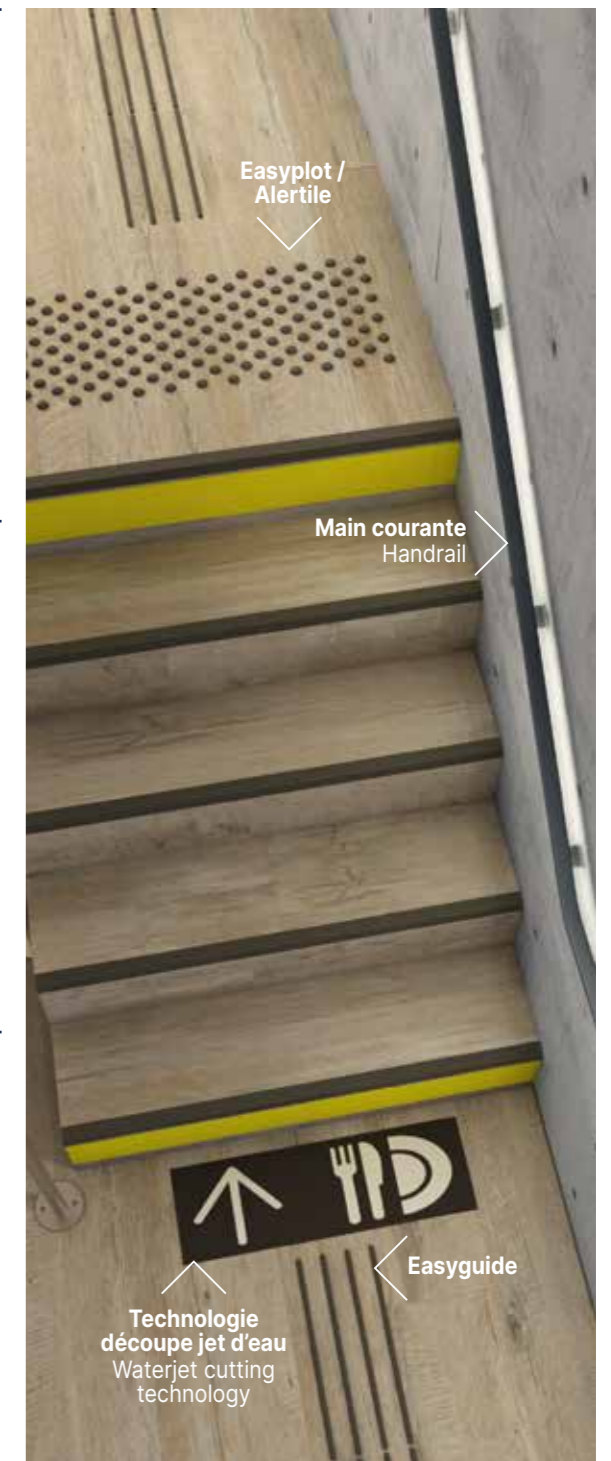

# Tarastep Pro



U4 17 dB



100% recyclable



2338 Sand & Brown  
<sup>(1)</sup> LRV : 41,7 / NCS : 3010-Y30R  
<sup>(2)</sup> LRV : 5,4 / NCS : 8005-Y20R  
**82% contrast**

Code produit :  
**1033 + code coloris**  
 Product code:  
 1033 + colour code

**Disponible à la coupe**  
 cutting service available

(1) Plat / Stair tread  
 (2) Nez de marche / Stair nosing

**100% compatible**  
 Taralay Impression  
 Cemento Capri (0524)



2333 Nature & Dark Grey  
<sup>(1)</sup> LRV : 39,8 / NCS : 3005-Y50R  
<sup>(2)</sup> LRV : 6,8 / NCS : 8000-N

**83% contrast**

**100% compatible**  
 Taralay Impression  
 Cemento Genova (0523)

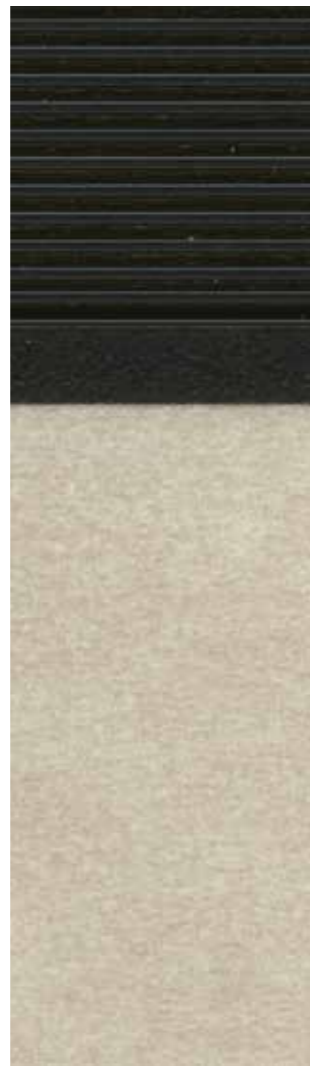

2342 Genova & Dark Grey  
<sup>(1)</sup> LRV : 47,6 / NCS : 3005-Y80R  
<sup>(2)</sup> LRV : 4,1 / NCS : 8502-B

**90% contrast**

**100% compatible**  
 Taralay Impression  
 Cemento Brescia (0543)



2336 Brescia & Black  
<sup>(1)</sup> LRV : 35,9 / NCS : 4005-Y80R  
<sup>(2)</sup> LRV : 4,1 / NCS : 8000-N

**84% contrast**



2343 Light Grey & Black  
<sup>(1)</sup> LRV : 42,9 / NCS : 3502-R  
<sup>(2)</sup> LRV : 4,6 / NCS : 8000-N

**85% contrast**



2341 Black & Light Grey  
<sup>(1)</sup> LRV : 10,3 / NCS : 7000-N  
<sup>(2)</sup> LRV : 54,5 / NCS : 2005-Y90R

**77% contrast**



2332 Silver & Dark Grey  
<sup>(1)</sup> LRV : 53,4 / NCS : 2502-R  
<sup>(2)</sup> LRV : 7,8 / NCS : 7500-N

**86% contrast**



2340 Warm Grey & Black  
<sup>(1)</sup> LRV : 27,5 / NCS : 4502-R  
<sup>(2)</sup> LRV : 6,8 / NCS : 8000-N

**77% contrast**



2339 Dark Grey & Yellow  
<sup>(1)</sup> LRV : 11,5 / NCS : 6502-R  
<sup>(2)</sup> LRV : 50,7 / NCS : 2040-Y40R

**73% contrast**



2334 Blue Grey & Clear  
<sup>(1)</sup> LRV : 13,1 / NCS : 6005-R80B  
<sup>(2)</sup> LRV : 50,0 / NCS : 3005-Y80R

**73% contrast**



2337 Deep Blue & Clear  
<sup>(1)</sup> LRV : 10,8 / NCS : 6020-R90B  
<sup>(2)</sup> LRV : 50,9 / NCS : 3005-Y80R

**77% contrast**



2344 Silver & Green  
<sup>(1)</sup> LRV : 53,1 / NCS : 2502-Y  
<sup>(2)</sup> LRV : 13,6 / NCS : 6005-B80G

**73% contrast**

**COMPATIBLE**  
 ACCESSIBILITÉ

Accessibility  
 Compatible

**73%**  
 DE CONTRASTE  
 MINIMUM

minimum  
 contrast



Sol / Flooring: Taralay Impression - Cemento Capri  
 Tarastep Pro - Capri & Black

**100% Match**



**Solution  
 hygiénique et  
 compatible  
 accessibilité**

Hygienic solution  
 complies with  
 Accessibility  
 requirements

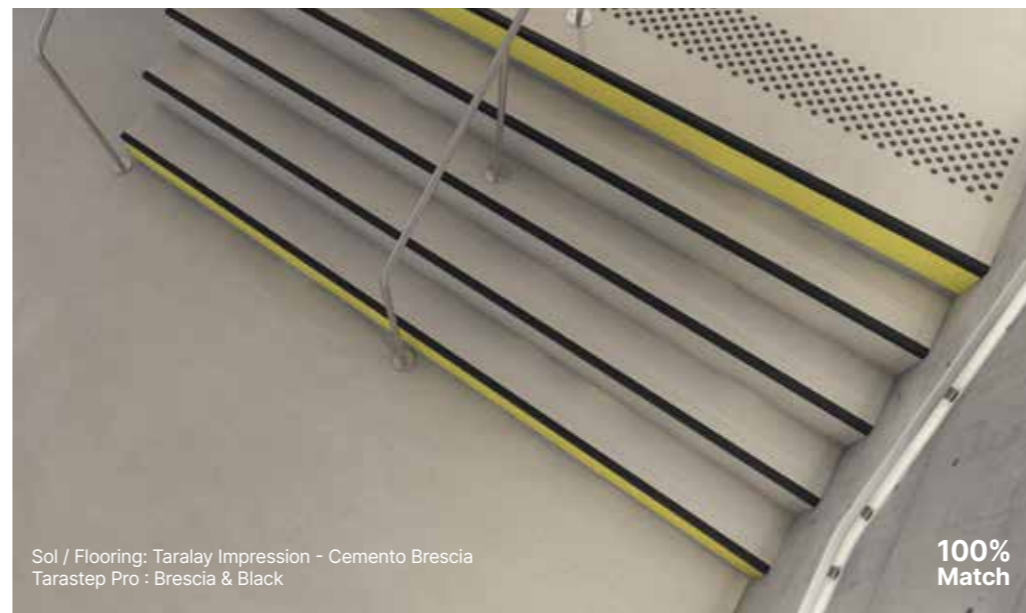

Sol / Flooring: Taralay Impression - Cemento Brescia  
 Tarastep Pro - Brescia & Black

**100% Match**



**Coloris conçus pour  
 être coordonnés  
 avec les gammes  
 rouleaux Taralay,  
 Mipolam...**

Colours are designed  
 to match with roll  
 products such as  
 Taralay, Premium,  
 Mipolam...

Taralay Impression  
 1070 Habana 3D Vinales



Tarastep Pro  
 2333 Nature & Dark Grey

Mipolam Affinity  
 4413 Marilyn



Tarastep Pro  
 2340 Warm Grey & Black

Premium Indiana  
 8256 Tahaa



Tarastep Pro  
 2339 Dark Grey & Yellow

Taralay Impression  
 1068 Gentlemen Denim

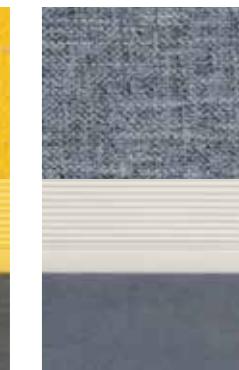

Tarastep Pro  
 2334 Blue Grey & Clear





## Nez de marche

### Stair nosing

COMPATIBLE  
ACCESSIBILITÉ  
Accessibility  
Compatible

**Solution adaptée à tous types d'escaliers et 100% coordonnée**  
Solution suitable for all types of stairs and 100% coordinated

### Nez de marche rainuré pour angles arrondis

Grooved PVC stair nosing (rounded angles and bird's beak)

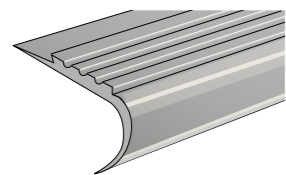

T27/3R  
0467

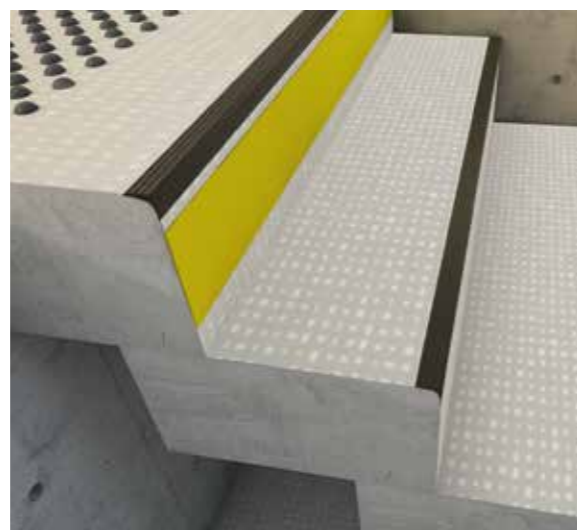

### Nez de marche rainuré pour angles droits

Grooved PVC stair nosing (straight angles)

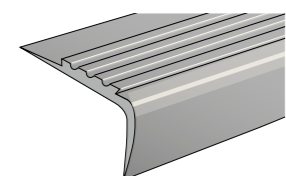

T49/4R - T49/3R - T49/2R  
0424 - 0462 - 0461

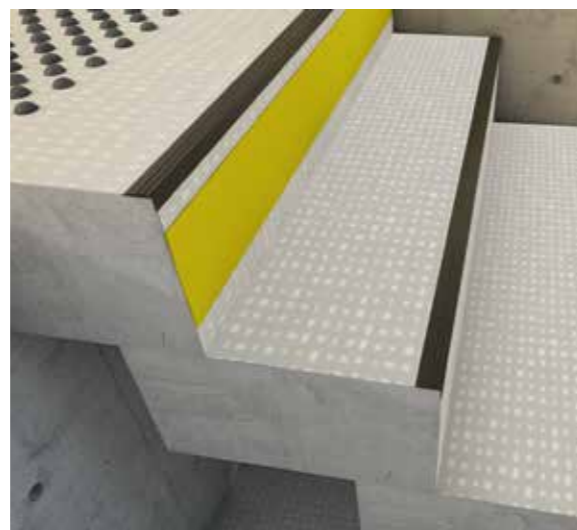

### Nez de marche aluminium

Aluminum stair nosing

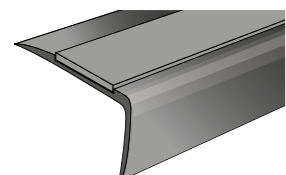

T67 Alu  
0503

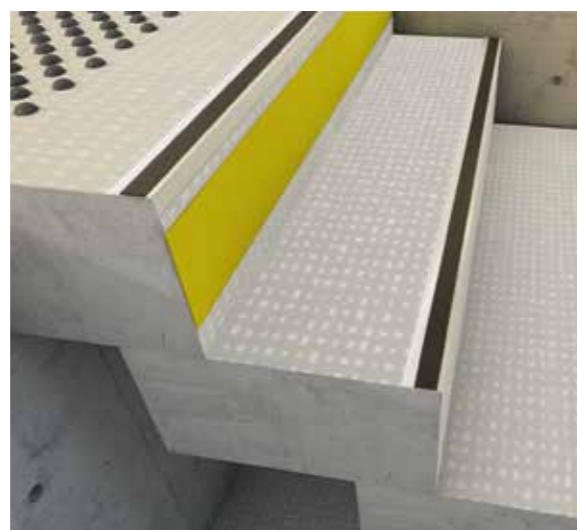

## Profilé design

### Design profile

### Nez-de-marche décoration

#### Stairnosing decoration

**Solution 100% coordonnée & compatible LVT, rouleau et linoleum**  
100% coordinated design solution with LVT, rolls or linoleum

**Code produit : E042**  
Product code : E042

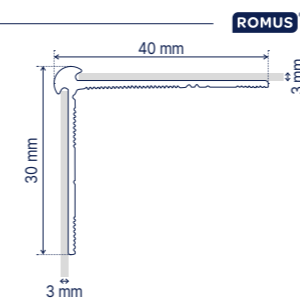

## Accessibilité

### Access for all

COMPATIBLE  
ACCESSIBILITÉ  
Accessibility  
Compatible

### Alertile

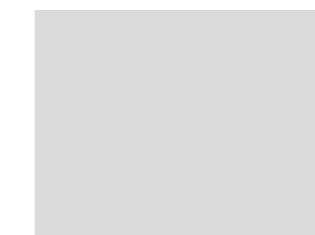

Gris / Light Grey  
0200



Gris foncé / Dark grey  
0300



Jaune / Yellow  
0400

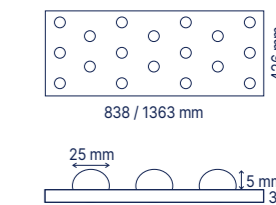

**Code produit : 059B (838 mm) / 059A (1363 mm) + code coloris**  
Product code : 059B (838 mm) / 059A (1363 mm) + colour code

### Easyplot



Aluminium  
0100

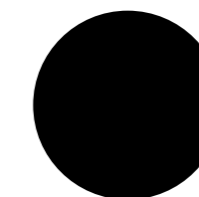

Noir / Black  
0003

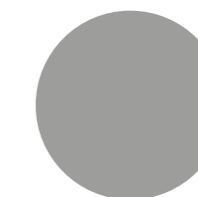

Gris / Grey  
0002

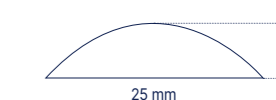

**Code produit : 059C / 059D**  
Product code : 059C / 059D

### Easyguide

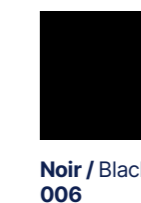
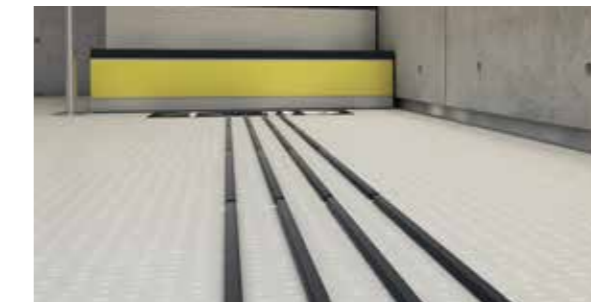

Noir / Black  
006

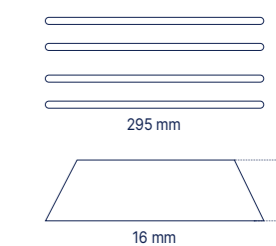

**Code produit : E219 + code coloris**  
Product code : E219 + colour code

### Adhésif contremarche contrasté

#### Adhesive



Blanc / White 0001 Jaune / Yellow 0005 Noir / Black 0003

**Code produit : 058M + code coloris**  
Product code : 058M + colour code

### Découpe jet d'eau personnalisée

#### Customised waterjet cutting





\* Information sur le niveau d'émission de substances volatiles dans l'air intérieur, présentant un risque de toxicité par inhalation, sur une échelle de classe allant de A+ (très faibles émissions) à C (fortes émissions)

## Tarastep Pro

### Description

Épaisseur totale / Total thickness	EN ISO 24346	mm	3.45
Épaisseur couche d'usure / Thickness of wearlayer	EN ISO 24340	mm	1.00
Poids / Weight	EN ISO 23997	g/m <sup>2</sup> / g/sq.m	3005
Largeur des lés / Width of sheet	EN ISO 24341	cm	100
Longueur des lés / Length of sheet	EN ISO 24341	ml / lm	20

### Classification

Norme / Norm / Product specification	-	-	EN 11638
Classement européen / European classification	EN ISO 10874	classe / class	34 – 42
Classement UPEC / UPEC Classification	-	-	U4P3E2C2
Certification  (evaluation.cstb.fr)	QB 30	n° certificat	Dossier en cours sous le numéro 22.4023
Isolation acoustique bruit de chocs / Impact sound insulation	EN ISO 717-2	dB	17
Sonorité à la marche / Walking sound	NFS 31 074	dB	< 65
Réaction au feu / Fire rating	EN 13 501-1	classe / class	Bfl-s1
Potentiel de charge / Static electrical propensity	EN 1815	kV	< 2
Glissance / Slip resistance wet: ramp test with oil	DIN 51130	classe / class	R10

### Performance

Résistance à l'usure / Wear resistance	EN 660.2	mm <sup>3</sup>	≤ 2.0
Groupe d'abrasion / Wear group	QB 30	groupe / group	T
Stabilité dimensionnelle / Dimensional stability (requirement)	EN ISO 23999	%	≤ 0.40
Poinçonnement statique rémanent / Residual indentation (value)	EN ISO 24343-1	mm	≤ 0.20
Poinçonnement : valeur moyenne mesurée / Residual indentation (requirement)	-	mm	≈ 0.10
Conductivité thermique / Thermal conductivity	EN ISO 10456	W/(m.K)	0.25
Solidité lumière / Colour fastness	EN 20 105 - B02	degré / degree	≥ 6
Traitement de surface / Surface treatment	-	-	Protecsol®
Résistance aux produits chimique / Chemical product resistance <sup>(1)</sup>	EN ISO 26987	-	OK
Activité anti-bactérienne / Anti-bacterial activity (E. coli – S. aureus – MRSA) <sup>(2)</sup>	ISO 22196	-	> 99% - ne favorise pas la prolifération / Inhibits growth
Activité anti-virale (coronavirus humain 229E) / Antiviral activity (human coronavirus 229E) <sup>(2)</sup>	ISO 21702	-	> 99.3% après 2h activité virucide / after 2h

### Environnement / Qualité de l'air / CE Marking

TVOC après 28 jours / TVOC after 28 days	ISO 16000-6	µg/m <sup>3</sup>	< 100
Certification	-	-	Floorscore®

### Marquage CE / CE Marking

	EN 14 041	-	   
--	-----------	---	---

(1) Tableau de résistance aux produits chimiques téléchargeable sur notre site internet / Regarding the resistance to chemicals, please download the corresponding leaflet from our website.  
 (2) Le respect des protocoles d'entretien des sols est la meilleure garantie contre les infections / The implementation of an effective cleaning regime is the best defence against infection

**IMPORTANT :** Les informations contenues dans ce document sont valables à compter du : 01/05/2023 et susceptibles d'être modifiées à tout moment et sans préavis. L'évolution de la technique étant permanente, il appartient à notre clientèle avant toute mise en œuvre, de vérifier auprès de nos services que le présent document est bien celui en vigueur.

**IMPORTANT:** The information contained in this document is valid from 01/05/2023 and is subject to change at any time without notice. In the context of constantly changing technology, our customers are responsible, prior to any use, for checking with us that this document is the version in force.

## We care / we act Our Commitments for a Sustainable future

 <b>CARBON FOOTPRINT*</b> -20 % kg CO <sub>2</sub> equivalent/m <sup>2</sup> between 2020 and 2025	 <b>BIO-SOURCED CONTENT**</b> 10 % by 2025	 <b>RECYCLED CONTENT</b> 30 % by 2025	 <b>ADHESIVE FREE***</b> 35 % by 2025	 <b>ANNUAL VOLUME RECYCLED</b> 60 000 t by 2025
--	---	--	--	--



\* Scopes 1 and 2 defined in the GHG protocol \*\* % of activity with biosourced materials \*\*\* % of activity - adhesive free solution